



# MURI A SECCO O REGGITERRA





# MURELLO

## Blocchi V24

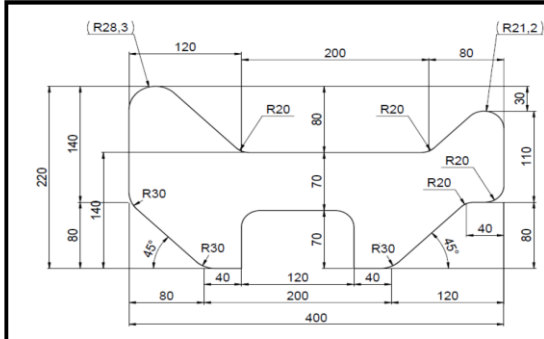

MISURE	24x40xh14
TOLLERANZE LxL mm	Larg x Lung ±2
TOLLERANZE H mm	Altezza ±3
N PER PIANO NEL PACCO	10
PESO PER PACCO kg	1000
N PEZZI PER PACCO	40
PESO KG CADAUNO	25
MQ X PACCO ACCOSTATO	1,43
MQ X PACCO DISTANZIATO	1,9

Codice	Descrizione	N. pian.	Peso Kg/cad.	Prezzo €/cad.	N di pezzi a mq.
BV24	Grigio naturale	40	25	4,50	n 21 pz muro distanziato n 28 pz. muro accostato
BV24C	Monocolore	40	25	5,80	

Monocolori disponibili 920G-965G

MURO CON PENDENZA  
VERSO LA PARETE DA  
SOSTENERE

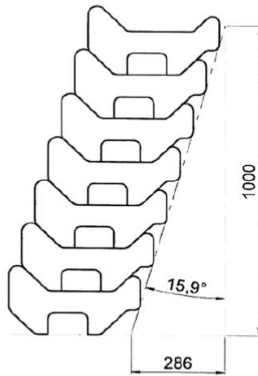

MURO VERTICALE A  
SECCO MAX h 100 cm

TIPOLOGIE DI POSA

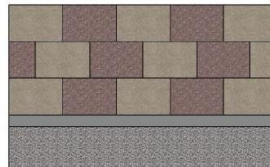

accostato

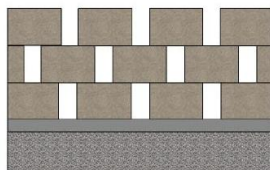

distanziato





BASONELLA  
by CEDEM

# FLORA

Serie Flora

Prodotto non spallettizzabile



## Blocchi C 4533

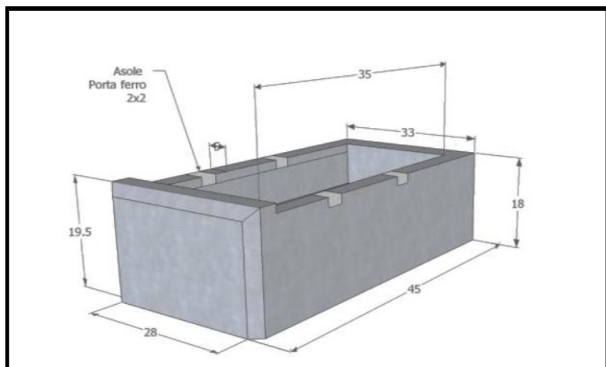

MISURE	45x33x18
TOLLERANZE LxL mm	Larg x Lung ±2
TOLLERANZE H mm	Altezza ±3
N PER PIANO NEL PACCO	4
PESO PER PACCO kg	600
N PEZZI PER PACCO	24
PESO KG CADAUNO	25
MQ X PACCO ACCOSTATO	1,5
MQ X PACCO DISTANZIATO	2



Codice	Descrizione	N. pian.	Peso Kg/cad.	Prezzo €/cad.	N di pezzi a mq.
BC4533	Grigio naturale	28	25	7,30	n 12 pz muro distanziato n 18 pz. muro accostato
BC4533C	Monocolore	28	25	8,50	

Monocolori disponibili 920G-965G

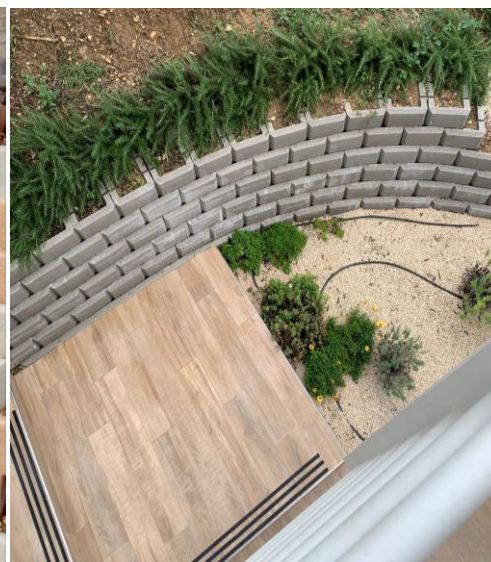



# MURI REGGITERRA



## SERIE MURO FIORITO ONDINA, PIANA, VERTICALE LISCIO E RIGA



ONDINA

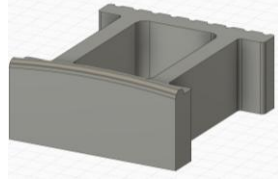

PIANA

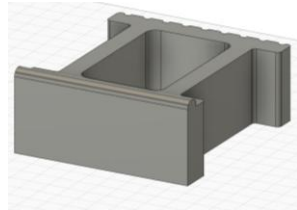

VERTICALE LISCIO

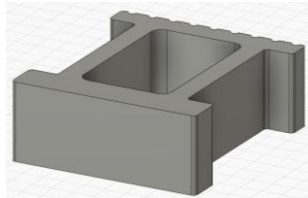

MISURE	50LX45PH19
TOLLERANZE	LargxLungh ± 2 mm
TOLLERANZE H mm	Altezza ± 3 mm
N PER PACCO	24
PESO KG CAD	40
PESO PACCO KG	960

Modello depositato esclusivo a marchio CEDEM non riproducibile.

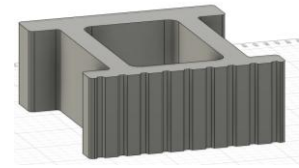

VERTICALE RIGATO

Codice	Descrizione	N. pian.	Peso Kg/cad.	Prezzo €/cad.	N di pezzi a mq.
BC5045	Grigio naturale	24	40	10,30	n 8 pz muro distanziato n 12 pz. muro accostato
BC5045C	Monocolore	24	40	12,30	
BC5045CM	COLOR MIX	24	40	14,00	

Monocolori disponibili arancio e giallo.

MIX G-B / A-B

NB. I muri fioriti Ondina e Piana vanno posati a ritroso di cm 4 per ogni elemento montato con faccia vista ondina o piana, lo spessore viene dato in automatico facendo battere l'elemento superiore alla spalla faccia vista dell'elemento sottostante che sporge in altezza.

Gli stessi elementi si possono montare girandoli sottosopra in questo caso avremo la battuta nella parte posteriore e la faccia vista rigata. La stessa serie può essere ordinata senza battente, quindi completamente liscia sotto e sopra per una posa in senso verticale con faccia vista liscia o rigata. In questo caso gli elementi possono essere gettati al loro interno e rinforzati con armatura in ferro. (verticale liscio e verticale rigato)

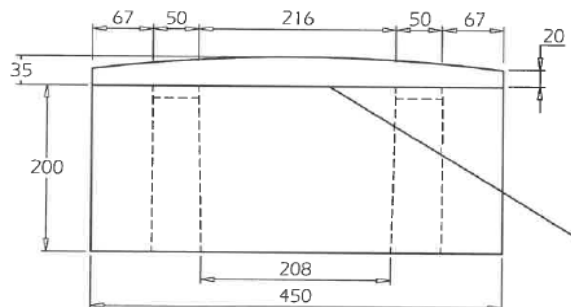
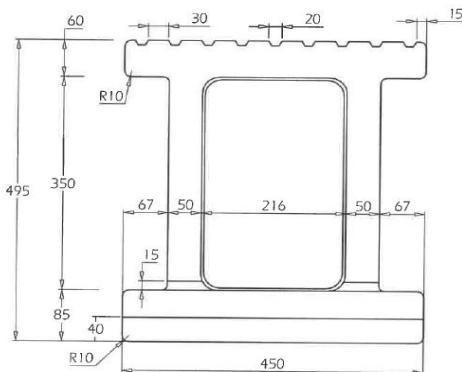

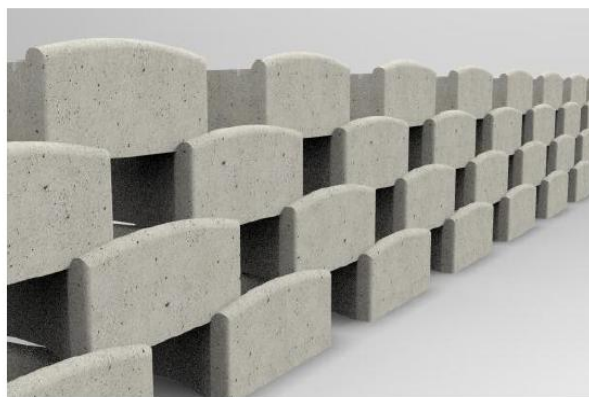



**Blocchi BSSPL2512**

Codice	Descrizione	N. pian.	Peso Kg/cad.	Prezzo €/cad.	N di pezzi a mq.
BSSPL25	Grigio naturale	96	15		n 32 pz. muro accostato
BSSPL25C	Monocolore	96	15		
BSSPL25B	Bianco	96	15		

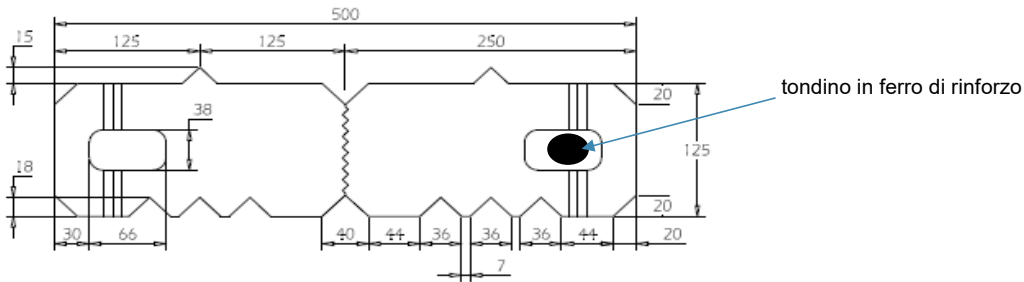

Il blocco selfsplit fa parte dei muri controterra posati a secco con o senza aiuto di georete .  
Il prodotto fornito come monoblocco unico verrà splittato prima della posa dall'operatore che eseguirà il lavoro. A mezzo di un'attrezzatura manuale si provvederà ad eseguire lo spacco o splittatura e poi successivamente la posa in verticale o a ritiro. Può essere rinforzato con l'aiuto di barre in acciaio posate all'interno del manufatto.

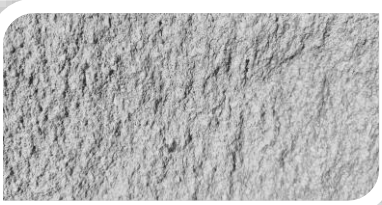

**GRIGIO NATURALE**



**GRIGIO ANTRACITE**



**BIANCO**

Prodotto momentaneamente non disponibile lo sarà a breve.

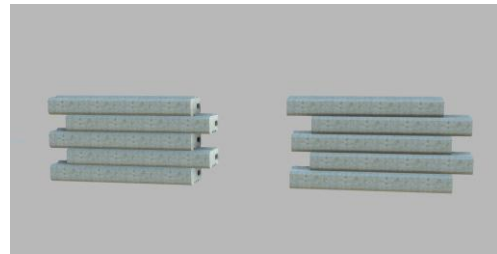

Punto dove splittare il prodotto

